

# Bias-Tee/Diplexer

**ZABT-2R15G+**

50Ω 10 to 2150MHz (10MHz, 950-2150MHz)



CASE STYLE: CC51

## The Big Deal

- Simple installation in a Satellite System
- Integrated 10 MHz diplexer and DC Bias-Tee
- Low RF Insertion Loss: 0.4 dB Typ 950-2150 MHz

## Product Overview

The ZABT-2R15G+ is a combination bias tee and diplexer designed specifically for satellite communications and wireless infrastructure applications. The ZABT-2R15G+ combines solid Mini-Circuits bias tee performance with additional functionality to inject 10 MHz reference clock without additional components. Built in a rugged shielded case, the ZABT-2R15G+ is equipped with SMA connectors for the L-Band ports and BNC connectors for DC and 10 MHz.

The ZABT-2R15G+ is ideally suited for powering Satellite up converters and LNBS where IF, DC and 10 MHz clock reference are all injected on a single coax cable.

## Key Features

Feature	Advantages
Filtered 10 MHz Port	Allows easy coupling of 10 MHz signals to coax for PLL reference clocks reducing cable runs. Blocks 10MHz from RF port reducing unwanted 10 MHz leakage.
DC Feed	Capable of handling up to 3 Amps and 25V, the ZABT-2R15G+ can power a wide range of remote amplifiers and converters.
Connectors	RF: SMA Female RF+REF+DC: SMA Female REF: BNC Female DC: BNC Female
Bi-Directional Operation	Can be used at both ends of a feed to inject DC and 10 MHz or to strip them at the other end.

**Notes**

- A. Performance and quality attributes and conditions not expressly stated in this specification document are intended to be excluded and do not form a part of this specification document.
- B. Electrical specifications and performance data contained in this specification document are based on Mini-Circuit's applicable established test performance criteria and measurement instructions.
- C. The parts covered by this specification document are subject to Mini-Circuits standard limited warranty and terms and conditions (collectively, "Standard Terms"); Purchasers of this part are entitled to the rights and benefits contained therein. For a full statement of the Standard Terms and the exclusive rights and remedies thereunder, please visit Mini-Circuits' website at [www.minicircuits.com/MCLStore/terms.jsp](http://www.minicircuits.com/MCLStore/terms.jsp)



# Bias-Tee / Diplexer

50Ω 10 to 2150MHz (10MHz, 950-2150MHz)

## ZABT-2R15G+



CASE STYLE: CC51

Connectors Model  
BNC-SMA FEMALE ZABT-2R15G+

**+RoHS Compliant**

The +Suffix identifies RoHS Compliance. See our web site for RoHS Compliance methodologies and qualifications

### Maximum Ratings

Operating Temperature	-55°C to 100°C
Storage Temperature	-55°C to 100°C
RF Power	30 dBm Max.
Voltage at DC port	25 V Max.
Input Current	3A
DC resistance from DC to RF&REF&DC port	0.5 Ohm Typ.

Permanent damage may occur if any of these limits are exceeded.

### Coaxial Connections

RF	1 (SMA female)
RF&REF&DC	2 (SMA female)
REF	3 (BNC female)
DC	S (BNC female)

### Features

- Low insertion loss, 0.5dB Typ.
- Good Isolation, 50dB Typ.

### Applications

- Satellite IF band
- Satellite Receivers / Transmitters
- Test accessory

### Electrical Specifications (T<sub>AMB</sub> = 25°C)

INSERTION LOSS* (dB)				ISOLATION* (dB)						VSWR (:1)					
Port 3 to Port 2		Port 1 to Port 2		Port 3 to Port 1		Port 1 to Port 3		Port 1 to Port S Port 2 to Port S		Port 2 & Port 3		Port 1 & Port 2			
10MHz		950-2150MHz		10MHz		950-2150MHz		10MHz		950-2150MHz		10MHz		950-2150MHz	
Typ.	Max.	Typ.	Max.	Typ.	Min.	Typ.	Min.	Typ.	Min.	Typ.	Min.	Typ.	Max.	Typ.	Max.
0.5	0.8	0.4	1.5	90	70	65	35	40	27	50	30	1.4	1.8	1.2	1.6

\* Insertion Loss and Isolation are guaranteed up to 24dBm RF power and 2A DC current.

### Outline Drawing

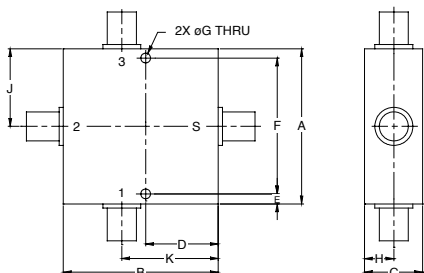

### Outline Dimensions (inch/mm)

A	B	C	D	E		
2.00	2.00	.75	.938	.13		
50.80	50.80	19.05	23.83	3.30		
F	G	H	J	K	wt.	
1.750	.125	.38	1.00	1.25	grams	
44.45	3.17	9.65	25.40	31.75	200	

### Typical Performance Data

FREQ. (MHz)	INSERTION LOSS (dB) (P <sub>IN</sub> = 0dBm) with Current				ISOLATION (dB) (P <sub>IN</sub> = 0dBm) with Current				VSWR (:1) Port 2
	Port 1 to Port 2				Port 1 to Port S				
	0.1A	0.5A	1A	2A	0.1A	0.5A	1A	2A	
2	86.95	84.64	82.68	81.32	85.68	90.10	83.56	79.73	1.37
5	91.38	86.70	91.88	86.01	86.74	94.04	87.43	85.23	1.18
10	82.34	84.06	86.00	88.08	99.69	90.41	102.84	87.90	1.15
25	85.21	88.30	81.14	84.82	81.77	85.93	88.44	86.66	1.26
50	71.95	71.34	71.13	75.94	92.18	81.98	77.94	85.73	1.72
100	48.89	49.05	48.87	49.07	80.26	82.35	84.53	82.73	5.26
500	1.28	1.27	1.27	1.29	55.22	55.53	55.58	55.65	2.24
900	0.30	0.29	0.29	0.30	63.80	64.06	63.66	63.90	1.11
950	0.28	0.28	0.27	0.28	62.39	63.41	65.26	67.45	1.12
1000	0.30	0.30	0.30	0.30	61.29	62.63	63.10	65.87	1.15
1100	0.30	0.29	0.30	0.30	63.07	64.61	62.95	61.13	1.20
1250	0.34	0.34	0.34	0.34	58.61	58.80	58.99	59.10	1.27
1400	0.37	0.38	0.38	0.38	52.47	52.25	51.95	51.98	1.31
1500	0.40	0.39	0.40	0.40	49.52	49.43	49.61	49.65	1.32
1700	0.41	0.41	0.41	0.41	44.39	44.64	44.61	44.68	1.29
1800	0.44	0.44	0.42	0.43	42.46	42.53	42.45	42.39	1.25
2000	0.46	0.47	0.46	0.47	38.42	38.36	38.40	38.44	1.16
2100	0.51	0.51	0.51	0.52	36.33	36.36	36.37	36.37	1.14
2150	0.54	0.54	0.54	0.55	35.32	35.32	35.34	35.34	1.15
2200	0.58	0.58	0.59	0.58	34.28	34.26	34.30	34.26	1.18

### Functional Block Diagram

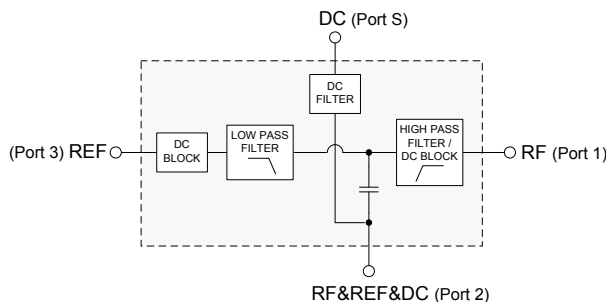

### Notes

- A. Performance and quality attributes and conditions not expressly stated in this specification document are intended to be excluded and do not form a part of this specification document.  
 B. Electrical specifications and performance data contained in this specification document are based on Mini-Circuit's applicable established test performance criteria and measurement instructions.  
 C. The parts covered by this specification document are subject to Mini-Circuits standard limited warranty and terms and conditions (collectively, "Standard Terms"); Purchasers of this part are entitled to the rights and benefits contained therein. For a full statement of the Standard Terms and the exclusive rights and remedies thereunder, please visit Mini-Circuits' website at [www.minicircuits.com/MCLStore/terms.jsp](http://www.minicircuits.com/MCLStore/terms.jsp)



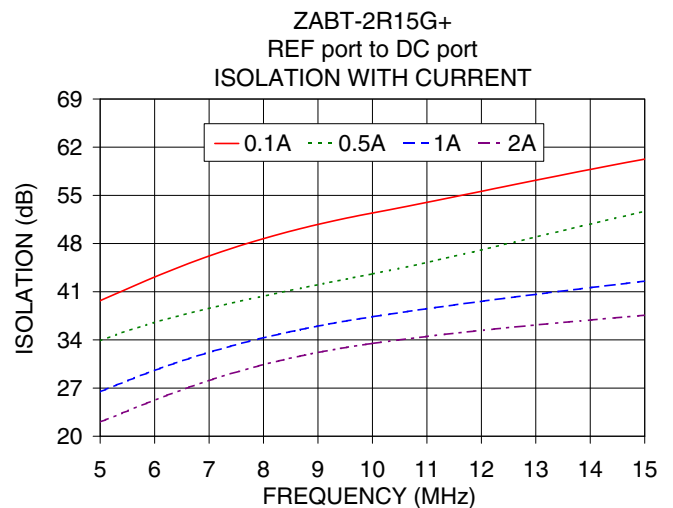
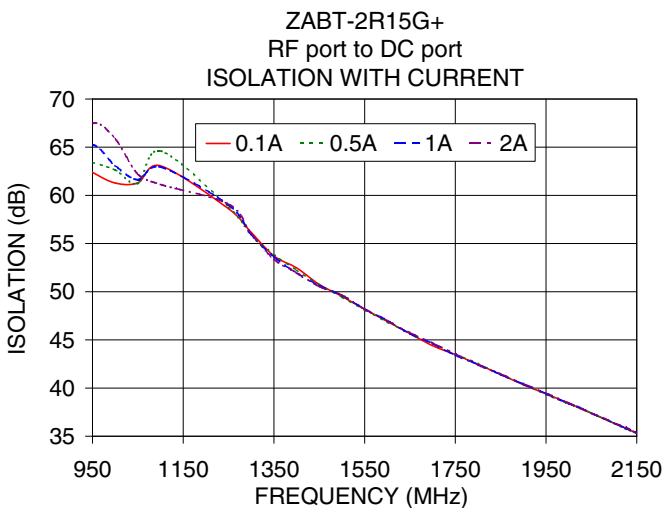
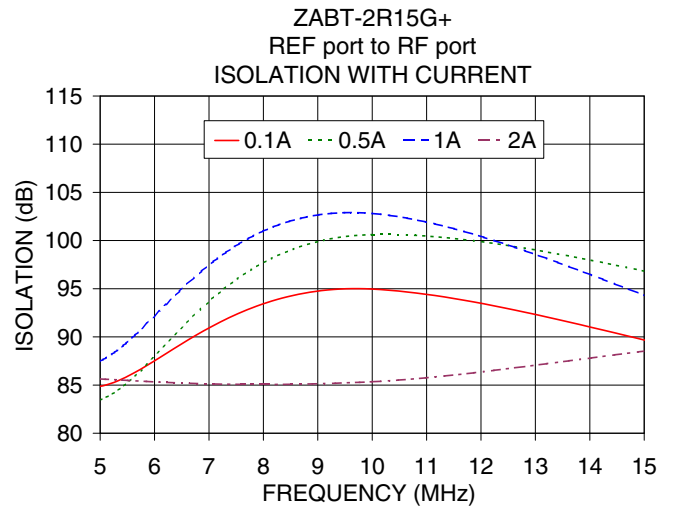
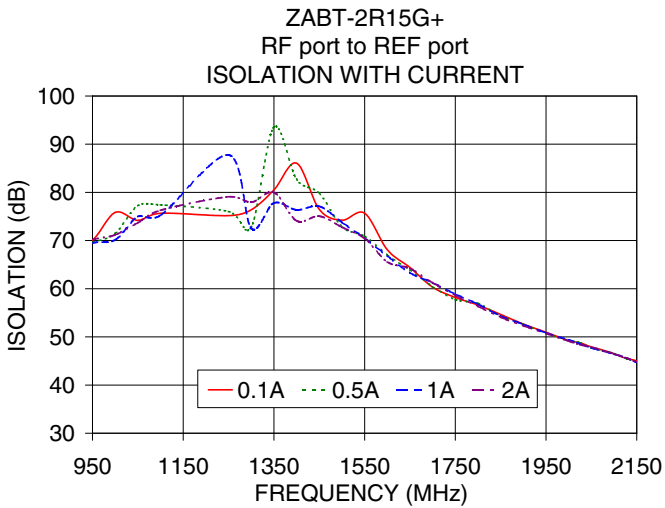
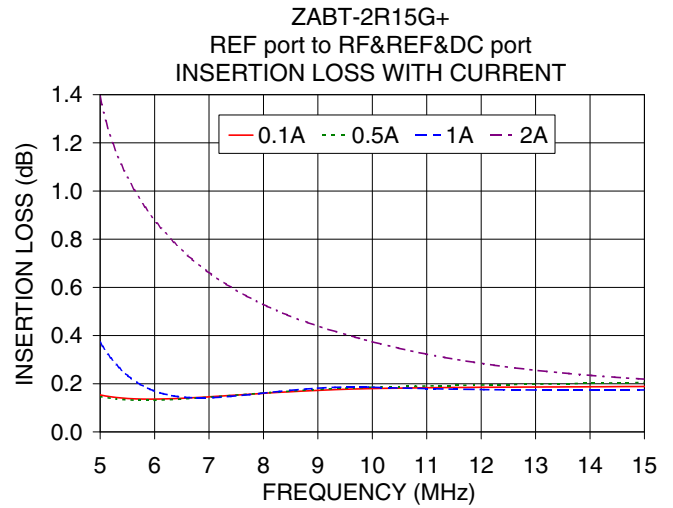
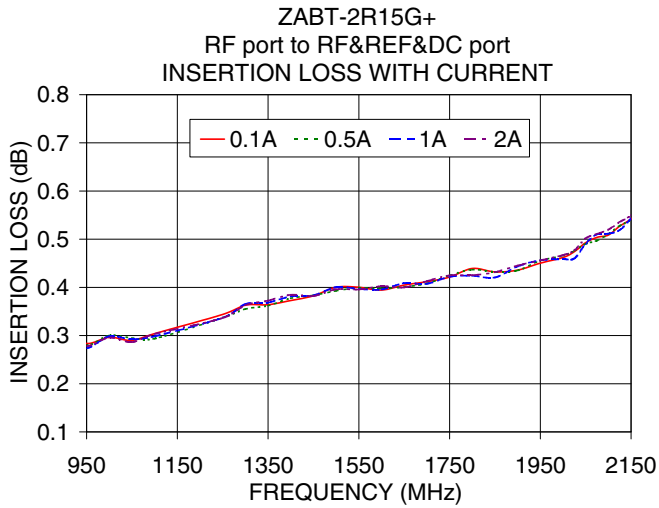

Notes

- A. Performance and quality attributes and conditions not expressly stated in this specification document are intended to be excluded and do not form a part of this specification document.
- B. Electrical specifications and performance data contained in this specification document are based on Mini-Circuit's applicable established test performance criteria and measurement instructions.
- C. The parts covered by this specification document are subject to Mini-Circuits standard limited warranty and terms and conditions (collectively, "Standard Terms"); Purchasers of this part are entitled to the rights and benefits contained therein. For a full statement of the Standard Terms and the exclusive rights and remedies thereunder, please visit Mini-Circuits' website at [www.minicircuits.com/MCLStore/terms.jsp](http://www.minicircuits.com/MCLStore/terms.jsp)



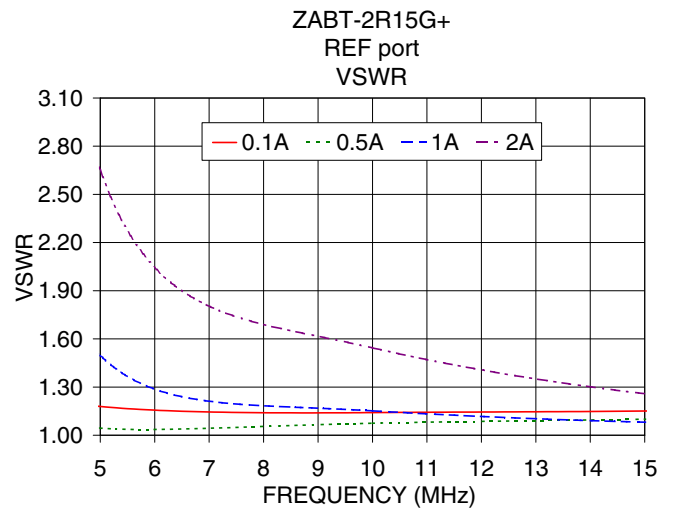
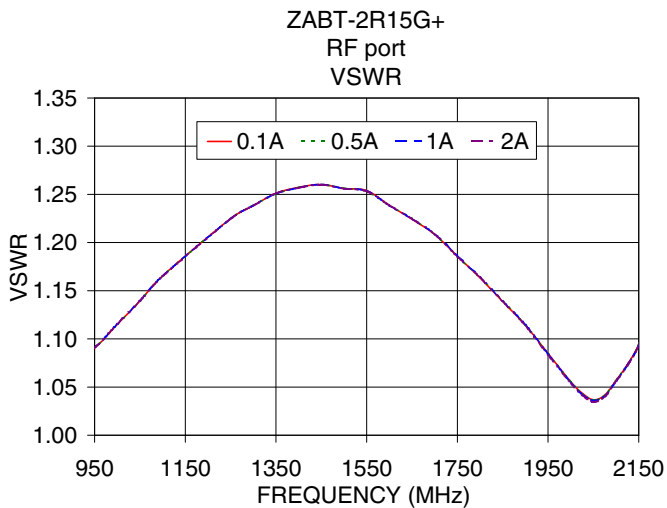
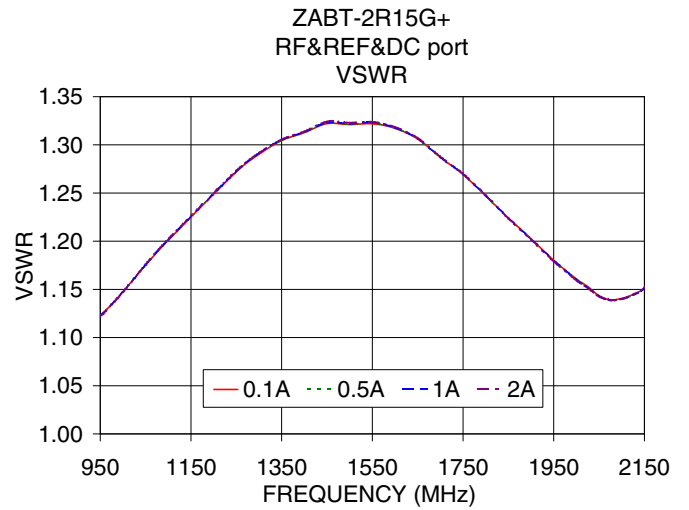
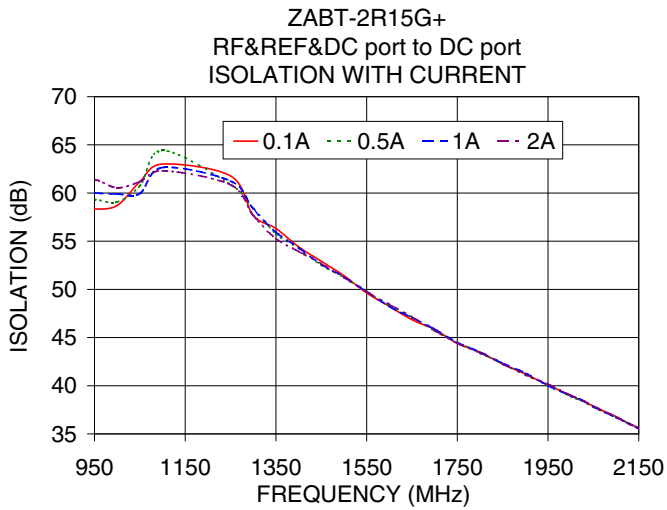

**Notes**

- A. Performance and quality attributes and conditions not expressly stated in this specification document are intended to be excluded and do not form a part of this specification document.
- B. Electrical specifications and performance data contained in this specification document are based on Mini-Circuit's applicable established test performance criteria and measurement instructions.
- C. The parts covered by this specification document are subject to Mini-Circuits standard limited warranty and terms and conditions (collectively, "Standard Terms"); Purchasers of this part are entitled to the rights and benefits contained therein. For a full statement of the Standard Terms and the exclusive rights and remedies thereunder, please visit Mini-Circuits' website at [www.minicircuits.com/MCLStore/terms.jsp](http://www.minicircuits.com/MCLStore/terms.jsp)

