

AN-60-042

TD-SCDMA Base Station MMIC Amplifier

Mini-Circuits PHA-1+ Ultra High Dynamic Range MMIC Amplifier is designed specifically for applications which require extremely linear performance, particularly wideband, advanced digital communications systems such as TD-SCDMA which require excellent ACLR suppression and low EVM.

The E-PHEMT based PHA-1+ provides typically +42 dBm OIP3 which translates to extremely linear performance in multi-carrier and complex signal environments such as TD-SCDMA supporting ACLR₁ Measurements of better than -60 dBc at +10 dBm output and EVM of 0.57% (rms) and 2.95% (pk) at the same power.



Figure 1 (PHA-1+ Test Board)

DUT Configuration:

Device: PHA-1+ Test board
 Supply Voltage: 5.0V, 150 mA
 Temperature: 25°C

Test Signal:

TD-SCDMA
 Fc = 2000 MHz
 Single Channel
 Channel bandwidth: 1.6 MHz

Note: All data is referenced to the PCB connectors

CCDF

| | |
|---------|---------|
| 10% | 3.21 dB |
| 1.0% | 6.09 dB |
| 0.1% | 7.95 dB |
| 0.01% | 8.53 dB |
| 0.001% | 8.56 dB |
| 0.0001% | 8.56 dB |

Measurement Setup

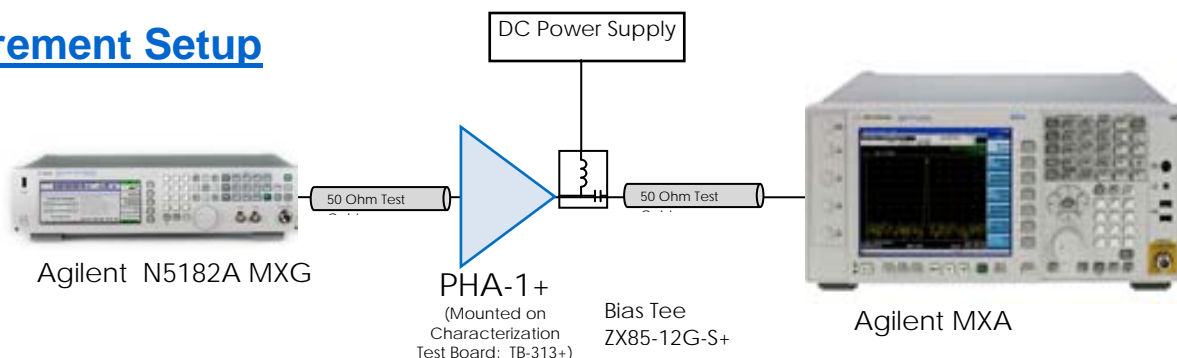

Summary Data

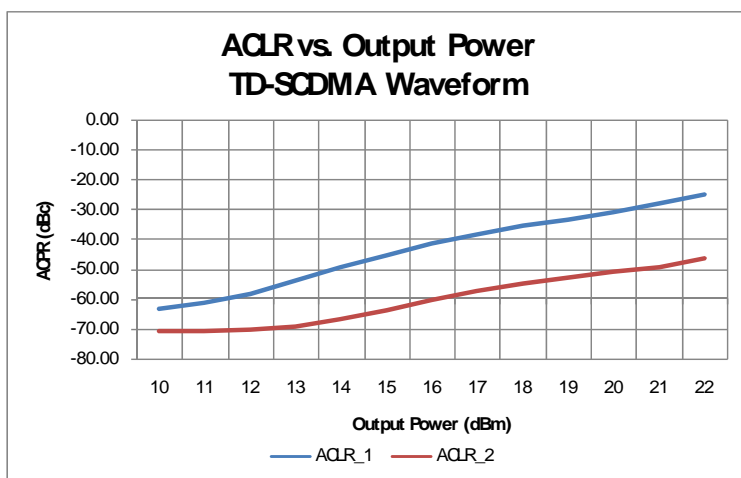
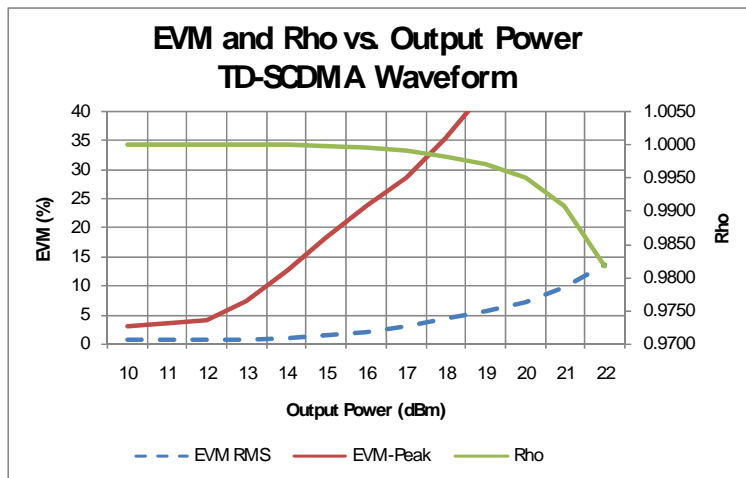

P.O. Box 350166, Brooklyn, New York 11235-0003 (718) 934-4500 Fax (718) 332-4661 For detailed performance specs & shopping online see Mini-Circuits web site



The Design Engineers Search Engine Provides ACTUAL Data Instantly From MINI-CIRCUITS At: www.minicircuits.com

RF/IF MICROWAVE COMPONENTS



ACLR_1 Plots vs. Output power

System Reference

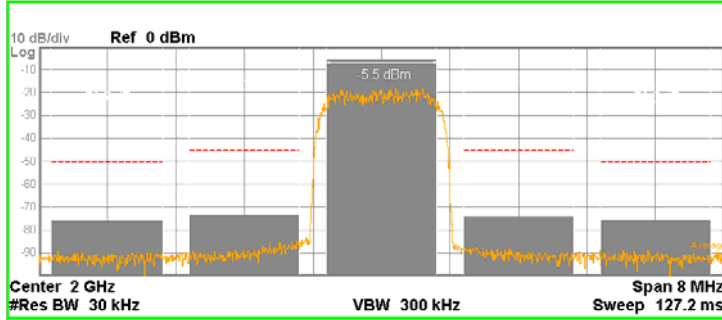

| Offset Freq | Integ BW | Lower | | Upper | |
|-------------|-----------|--------|--------|--------|--------|
| | | dBc | dBm | dBc | dBm |
| 1.600 MHz | 1.280 MHz | -68.03 | -73.57 | -69.08 | -74.63 |
| 3.200 MHz | 1.280 MHz | -70.66 | -76.21 | -70.46 | -76.01 |

+ 10 dBm

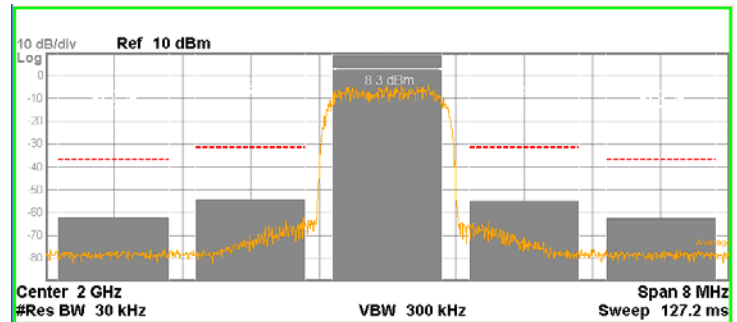

| Offset Freq | Integ BW | Lower | | Upper | |
|-------------|-----------|--------|--------|--------|--------|
| | | dBc | dBm | dBc | dBm |
| 1.600 MHz | 1.280 MHz | -62.75 | -54.48 | -63.38 | -55.11 |
| 3.200 MHz | 1.280 MHz | -70.62 | -62.35 | -70.70 | -62.43 |

+ 12 dBm

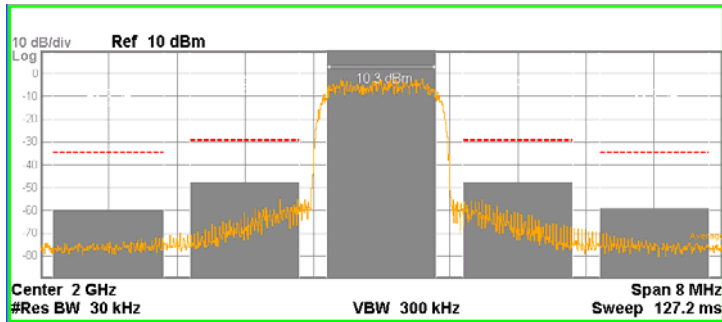

| Offset Freq | Integ BW | Lower | | Upper | |
|-------------|-----------|--------|--------|--------|--------|
| | | dBc | dBm | dBc | dBm |
| 1.600 MHz | 1.280 MHz | -58.27 | -47.97 | -58.24 | -47.94 |
| 3.200 MHz | 1.280 MHz | -70.20 | -59.90 | -69.76 | -59.47 |

+ 14 dBm

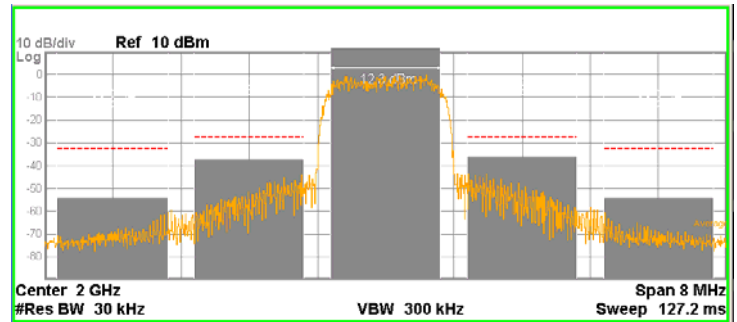

| Offset Freq | Integ BW | Lower | | Upper | |
|-------------|-----------|--------|--------|--------|--------|
| | | dBc | dBm | dBc | dBm |
| 1.600 MHz | 1.280 MHz | -49.78 | -37.51 | -48.81 | -36.54 |
| 3.200 MHz | 1.280 MHz | -66.78 | -54.50 | -66.84 | -54.56 |

+ 15 dBm

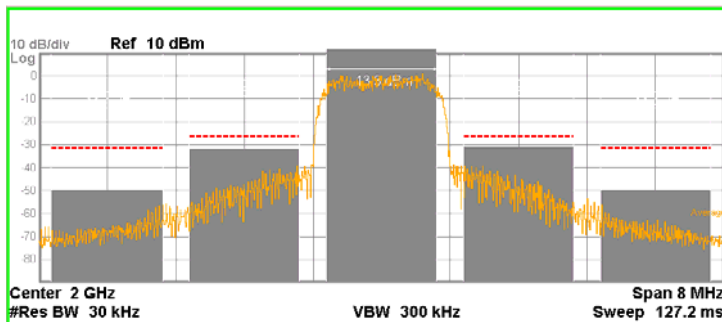

| Offset Freq | Integ BW | Lower | | Upper | |
|-------------|-----------|--------|--------|--------|--------|
| | | dBc | dBm | dBc | dBm |
| 1.600 MHz | 1.280 MHz | -45.46 | -32.17 | -44.63 | -31.35 |
| 3.200 MHz | 1.280 MHz | -63.75 | -50.47 | -63.92 | -50.64 |

+ 16 dBm

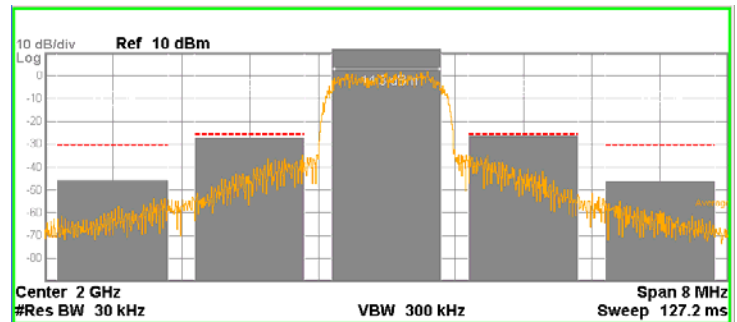

| Offset Freq | Integ BW | Lower | | Upper | |
|-------------|-----------|--------|--------|--------|--------|
| | | dBc | dBm | dBc | dBm |
| 1.600 MHz | 1.280 MHz | -41.60 | -27.33 | -40.94 | -26.67 |
| 3.200 MHz | 1.280 MHz | -60.17 | -45.90 | -60.53 | -46.26 |

IQ Polar Plots vs. Output Power (EVM, Rho and PCDE)

System Reference:

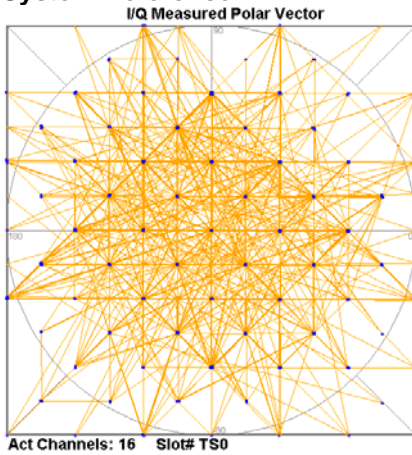

Slot# TS0
 Rho: 0.99997
 EVM: 0.57 % rms
 3.25 % pk
 Pk CDE: -54.03 dB
 at S16(10)

+10 dBm

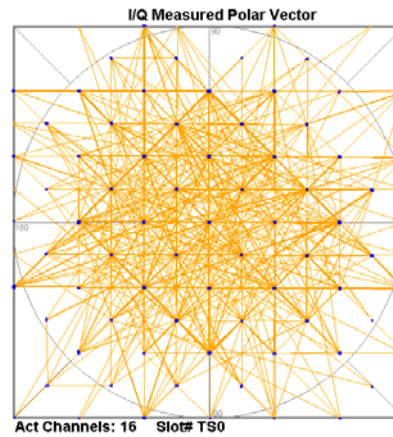

Slot# TS0
 Rho: 0.99997
 EVM: 0.57 % rms
 2.95 % pk
 Pk CDE: -54.39 dB
 at S16(0)

+12 dBm

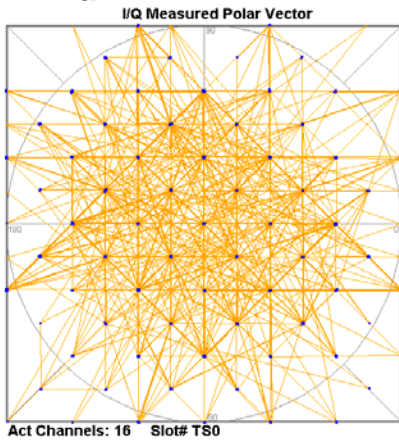

Slot# TS0
 Rho: 0.99996
 EVM: 0.60 % rms
 3.87 % pk
 Pk CDE: -53.92 dB
 at S16(2)

+14 dBm

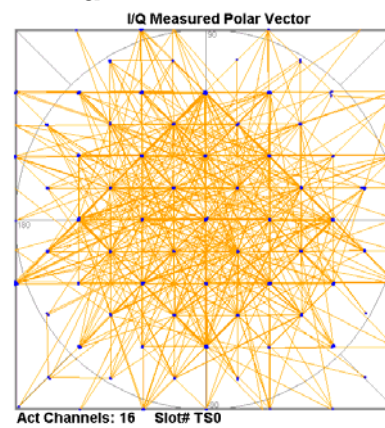

Slot# TS0
 Rho: 0.99992
 EVM: 0.89 % rms
 12.45 % pk
 Pk CDE: -50.30 dB
 at S16(7)

+15 dBm

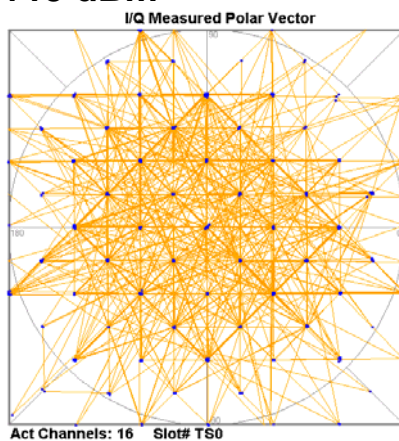

Slot# TS0
 Rho: 0.99983
 EVM: 1.32 % rms
 18.25 % pk
 Pk CDE: -47.51 dB
 at S16(0)

+16 dBm

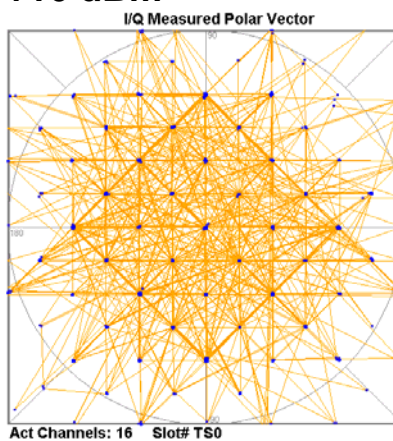

Slot# TS0
 Rho: 0.99960
 EVM: 2.00 % rms
 23.75 % pk
 Pk CDE: -44.10 dB
 at S16(7)